

PLUMBERS INSTALLATION INSTRUCTIONS For Vitreous China Cube Wall Faced Back Inlet Toilet Pan PLEASE READ CAREFULLY BEFORE INSTALLATION

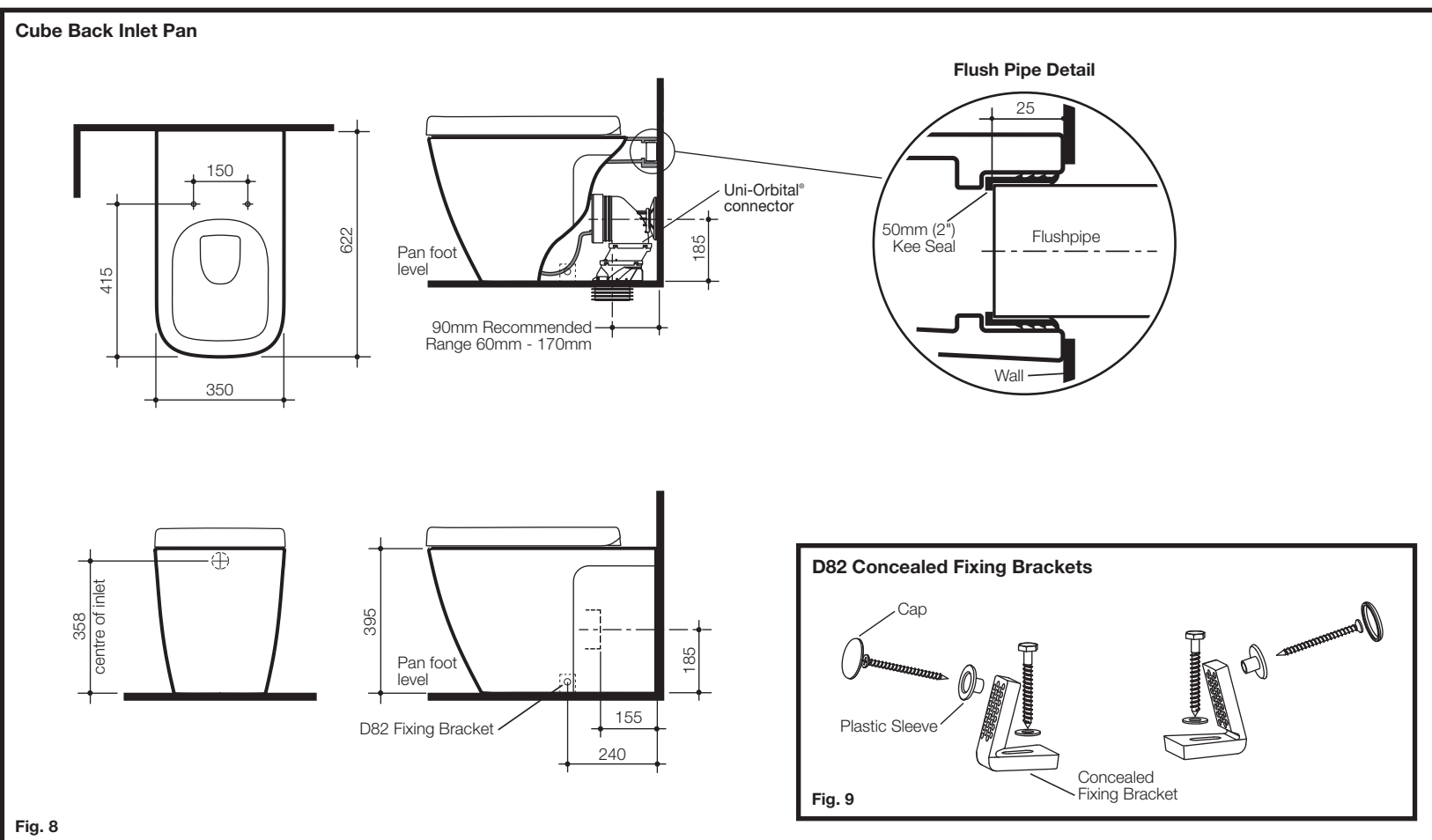
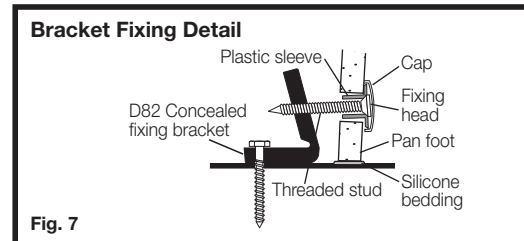
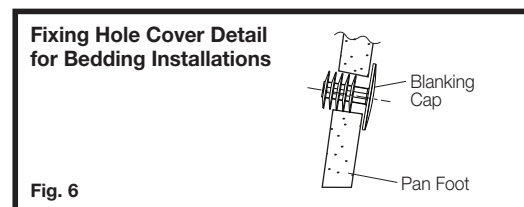
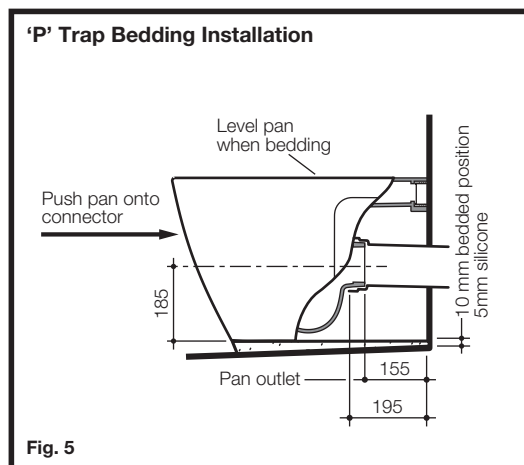
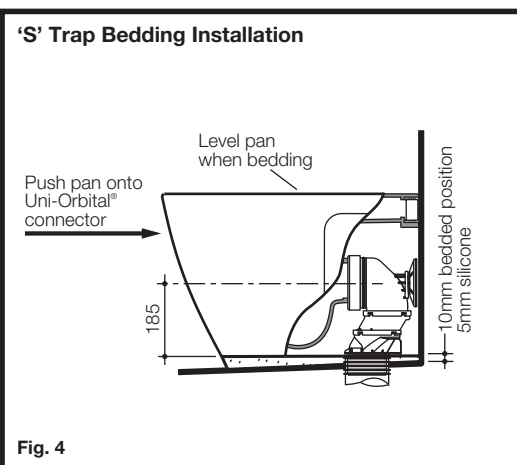
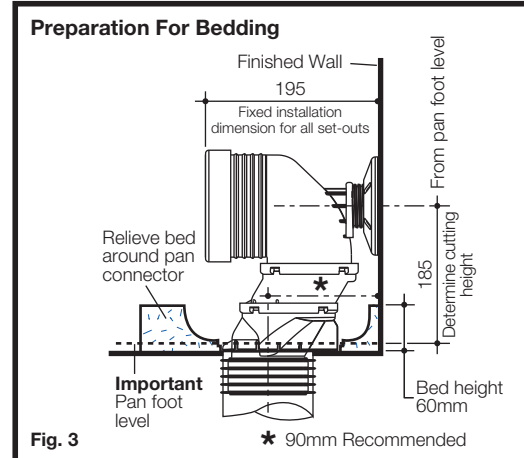
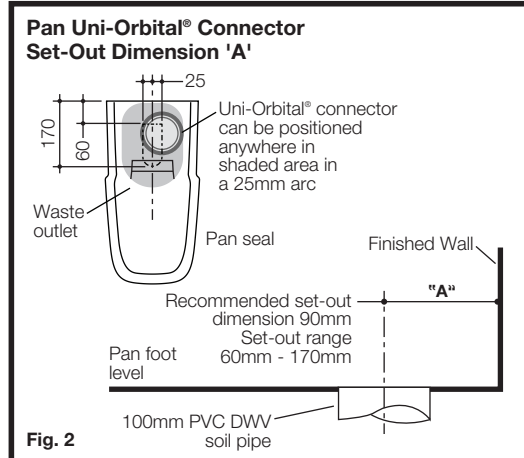
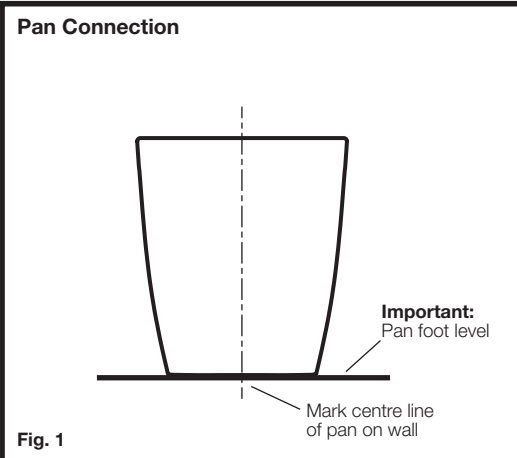

ROUGHING IN:

The Cube back inlet pan is universal for both 'S' and 'P'-Trap installations as detailed. The recommended set-out for 'S'-Trap installations is 90mm from the finished wall with set-out flexibility for existing soil pipe positions ranging from 60mm to 170mm and 25mm sideways adjustment with the Uni-Orbital® connector supplied.

'S'- TRAP CONNECTOR FIXING PROCEDURE

- 1- Mark centre line of the pan on finished wall, as detailed in Fig. 1. This is to be used as a guide when connecting the pan.
- 2- Determine set-out "A" of existing pan connector, as detailed in Fig. 2. Set-out range 60mm - 170mm. Recommended set-out 90mm, as detailed in Fig. 3. For 'P' trap installation see Fig. 5.
- 3- For installation of the Uni-Orbital® connector, reference must be made to the instructions supplied with the Uni-Orbital® connector.
- 4- Prepare for pan fixing method (either bedding or bracket installation) as detailed below.

PAN/CLOSET FIXING PROCEDURE

Pan bedding:

- 1- Remove an area of tiles which are within the internal area covered by the foot of the pan to expose the sub floor and provide a bondage key for the bedding mixture.
- 2- Ensure that the bedding area is clean and free of building material.
- 3- Locate blanking cap into pan fixing holes as detailed in Fig. 6.
- 4- Prepare bedding sand cement mixture 3:1 to depth of 60mm as detailed in Fig. 3.
Note: Do not fill the foot of the pan with bedding mix or include lime or fast drying cement into the mix, these may cause cracking in the foot of the pan.
- 5- Position and push pan into connector and flushpipe using the marked centre line on the wall as a guide and level pan into bedding mixture, so that the back of the foot of the pan is approximately 10mm above the finished floor as detailed in Fig. 4. It is recommended that wedges are used to support the foot of the pan during the positioning.

Bracket fixing:

- 1- Position and push pan into connector and flushpipe using the marked centre line on the wall as a guide to ensure that all fittings locate correctly. Remove the pan.
- 2- Locate the D82 Concealed Fixing Brackets (supplied) into position on centre line of pan 240mm from the finished wall and mark bracket fixing hole centres on finished floor.
- 3- Drill two holes in the marked positions on the floor. The hole diameter is dependent on the type of fixing system and floor finish.
- 4- Secure Brackets to finished floor.
- 5- Ensure that the area around the floor is clean and free from building material.
- 6- Run a bead of acetic cured silicone sealant at a height of 8mm approximately fully around the foot of the pan which

- contacts the floor. Use Wedges around the foot base (if required) so that the **maximum height of silicone sealant is not greater than 5mm on completion of bedding.**
- 7- Connect pan to connector and locate plastic sleeve into holes in the pan. Fit screw into the bracket and tighten to bed pan to floor while ensuring level, as detailed in Fig. 7. **IMPORTANT - DO NOT OVER TIGHTEN, AS THIS MAY CRACK THE PAN FOOT.** Snap on plastic cap, as detailed in Fig. 7.
 - 8- Provide support under the pan foot so that it is maintained in the levelled position while the silicone sealant sets. Remove any excess sealant to provide a neat joint between the pan and the floor. Allow at least 24 hours for the bedding sealant to set before use.

IMPORTANT
TO ACHIEVE A SATISFACTORY 4.5/3L FLUSH PERFORMANCE AND A 4 STAR WATER EFFICIENCY RATING THE CISTERN MUST BE MATCHED WITH A COMPATIBLE CAROMA SMARTFLUSH 4.5/3L TOILET PAN.

All measurements are subject to accepted manufacturing tolerances. To ensure accuracy please check actual product dimensions before drilling for installation. The manufacturer reserves the right to change specifications at any time without giving prior notification. This product should be installed by a qualified plumber. Local authority, Water Board, and Building Regulations may apply to the installation of this product, and you should consult the appropriate bodies on these requirements.